



Acabado con textura. Texture finish. Acabamento texturizado. Acabat amb textura. Akabera ukifua. Acabado con textura.



Cajón con organizador. Organizer unit. Gaveta com organitzador. Calaix amb organitzador. Antolatzailearekin tiradera. Caixa con organitzador.



Cierre amortiguado. Soft close. Com amortecedor. Tancament suau. Motelgailudun itxierazko. Peche amortecido.



Fronte cajón regulable. Adjustable front. Fronte da gaveta ajustável. Front calaix regulable. Neurirako kajoj aurrekaldea. Fronte axustable.



Guías Hettich. Hettich sliding system. Guías Hettich. Guies Hettich. Hettich gidak. Guías Hettich.



Acabado lacado brillo. Glossy lacquered finish. Cor lacado brillo. Acabat lacat brillant. Distiradun lakatzuko bukatua. Acabado lacado brillo.



Melamina con textura. Textured melamine. Melamina texturizada. Melamina amb textura. Testurako melamina. Melamina con textura.

- 3 cajones ajustables con cierre amortiguado. Tirador metálico.
- Patas ajustables en altura.
- Fronte 19 mm / Lateral 19 mm.
- 3 adjustable drawers with silentslow closing and metal handles.
- Height adjustable legs.
- 19 mm front / 19 mm side panels.

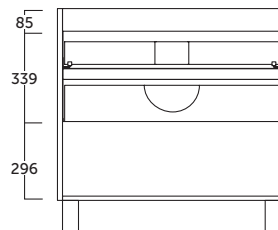

## escorpio.60 (23.6")

Acabado	Referencia
○ Blanco brillo	123 01 060
● Roble natural	123 24 060
● Pino gris	123 37 060
● Wengué nature	123 44 060

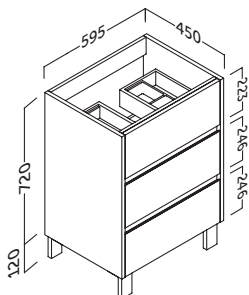

## escorpio.70 (27.5")

Acabado	Referencia
○ Blanco brillo	123 01 070
● Roble natural	123 24 070
● Pino gris	123 37 070
● Wengué nature	123 44 070

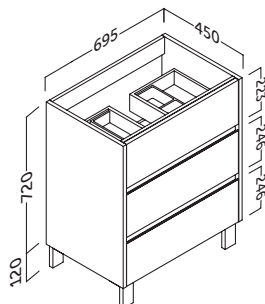

## escorpio.80 (31.5")

Acabado	Referencia
○ Blanco brillo	123 01 080
● Roble natural	123 24 080
● Pino gris	123 37 080
● Wengué nature	123 44 080

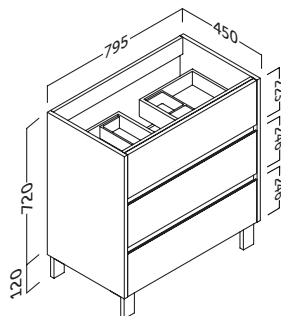

## escorpio.100 (39.4")

Acabado	Referencia
○ Blanco brillo	123 01 100
● Roble natural	123 24 100
● Pino gris	123 37 100
● Wengué nature	123 44 100

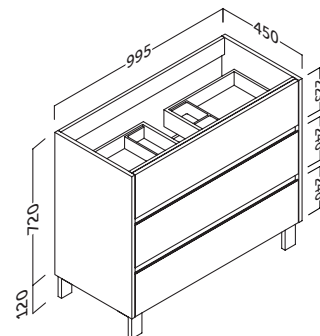

## joker.columna

Acabado	Referencia
○ Blanco brillo	137 01 335
● Roble natural	137 24 335
● Pino gris	137 37 335
● Wengué nature	137 44 335

Apertura reversible  
Reversible opening

El estante de cristal puede cambiar su posición +/- 64 mm.

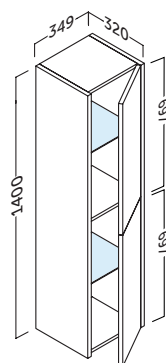

## joker.colgar

Acabado	Referencia
○ Blanco brillo	137 01 435
● Roble natural	137 24 435
● Pino gris	137 37 435
● Wengué nature	137 44 435

Apertura reversible  
Reversible opening

El estante de cristal puede cambiar su posición +/- 32 mm.

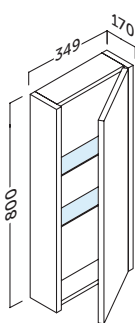

## joker.auxiliar

Acabado	Referencia
○ Blanco brillo	137 01 445
● Roble natural	137 24 445
● Pino gris	137 37 445
● Wengué nature	137 44 445

Apertura reversible  
Reversible opening

El estante de cristal puede cambiar su posición +/- 32 mm.

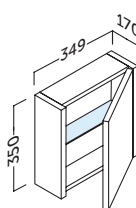

Cierre amortiguado. Soft close. Porta com amortecedor. Tancament suau. Motelgailudun itxierazko. Peche amortecido.



Apertura reversible. Reversible opening. Abertura reversível. Obertura reversibile. Irekitze itzulgarria. Apertura reversible.



MADE IN SPAIN