

# Tauro

\_70/80/100

Sigma  
Omega  
Landes  
Landes modular  
Strip  
Cairo  
Dúo  
Ikaro  
Denim  
Lip  
Wave  
Sky  
Trent  
Escorpio  
**Tauro\_**  
Wood  
Mar  
Hole  
Aries  
Galsaky  
Small  
Homy  
Comet  
Tívoli  
Moon  
Dominó

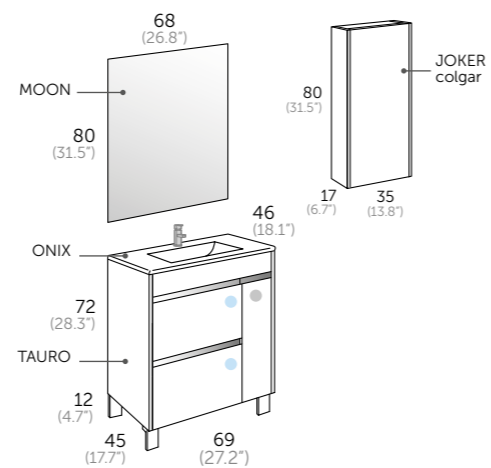



Composición **TAURO 70 (27.5")**

- 1 122 03 070 TAURO 70
- 1 500 01 070 ONIX
- 1 200 00 080 MOON

Auxiliares

- 1 137 03 435 JOKER colgar

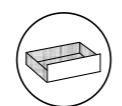

Interior cajones acabado textil  
*Interior of drawer textile finish*  
 Interiores gaveta em acabamento têxtil  
*Interior caiaix en acabat tèxtil*  
 Ehun-bukaeazko barnekaldean kajoia  
*Interior do caixón en acabado textil*



Cajón con cierre amortiguado  
*Drawer fitted with soft closing system*  
 Gaveta com sistema de corredeiras com amortecedor  
*Caiaixos amb sistema de tancament suau*  
 Motelgailudun itxierazko kajoia  
*Caixón con peche amortecido*

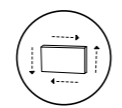

Frente cajón regulable  
*Adjustable front drawer*  
 Frente da gaveta ajustável  
*Frontal caiaix regulable*  
 Neurrirako kajoj aurrekaldea  
*Fronte do caixón axustable*



Puerta con cierre amortiguado  
*Door with soft closing system*  
 Porta com amortecedor  
*Porta amb sistema de tancament suau*  
 Motelgailudun itxierazko atea  
*Porta con peche amortecido*

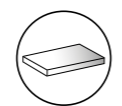

Acabado lacado brillo  
*High gloss lacquered finish*  
 Cor lacado brilho  
*Acabat lacat brillant*  
 Distiradun lakatzeko bukatua  
*Acabado lacado brillo*



Guías Hettich  
*Hettich drawer sliding system*  
 Guías Hettich  
*Guias Hettich*  
 Hettich gidak  
*Guias Hettich*

- Blanco  
White  
Branco  
Bianc  
Zuria  
Branco
- Gris  
Grey  
Cinzentu  
Gris  
Gris  
Gris
- Roble natural  
Natural oak  
Carvalho natural  
Roure natural  
Haritz naturala  
Carballo natural
- Roble medio  
Medium oak  
Carvalho médio  
Roure miçã  
Haritz ertainekoa  
Carballo medio
- Wengué  
Wenge  
Wenge  
Wengué  
Wenge  
Wengué



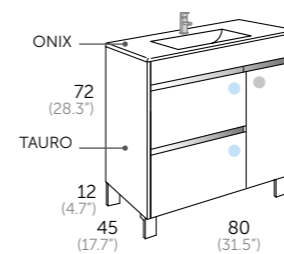

Composición **TAURO 80 (31.5")**

- 1 122 20 080 TAURO 80
- 1 500 01 080 ONIX



- Blanco (White, Branco, Blanc, Zuria, Branco)
- Gris (Grey, Cinzento, Gris, Grisa, Gris)
- Roble natural (Natural oak, Carvalho natural, Roure natural, Haritz naturala, Carballo natural)
- Roble medio (Medium oak, Carvalho medio, Roure mitjà, Haritz ertainekoa, Carballo medio)
- Wengué (Wenge, Wenge, Wenge)

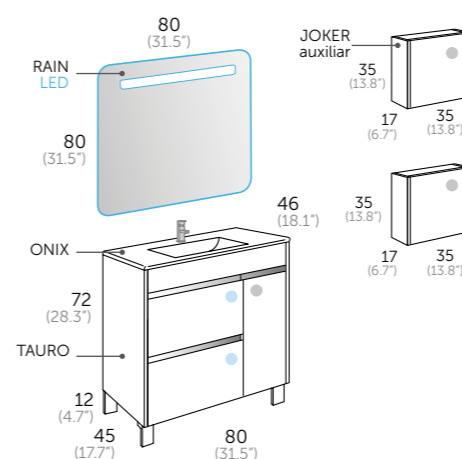

Composición **TAURO 80 (31.5")**

- 1 122 21 080 TAURO 80
- 1 500 01 080 ONIX
- 1 269 00 080 RAIN LED

Auxiliares

- 2 137 21 445 JOKER auxiliar

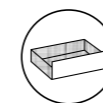

Interior cajones acabado textil  
 Interior of drawer textile finish  
 Interiores gaveta em acabamento têxtil  
 Interior calaix en acabat tèxtil  
 Ehun-bukaerazko barnekaldean kajoia  
 Interior do caixón en acabado textil

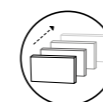

Cajón con cierre amortiguado  
 Drawer fitted with soft closing system  
 Gaveta com sistema de correções com amortecedor  
 Calaixos amb sistema de tancament suau  
 Motelgailudun itxierazko kajoia  
 Caixón con peche amortecido

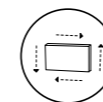

Frente cajón regulable  
 Adjustable front drawer  
 Frente da gaveta ajustável  
 Frontal calaix regulable  
 Neurrirako kajo aurrekaldea  
 Fronte do caixón axustable



Puerta con cierre amortiguado  
 Door with soft closing system  
 Porta com amortecedor  
 Porta amb sistema de tancament suau  
 Motelgailudun itxierazko atea  
 Porta con peche amortecido

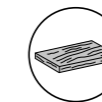

Acabado melamina con textura  
 Textured melamine finish  
 Cor melamina com textura  
 Acabat melamina amb textura  
 Testuradun melamina bukatua  
 Acabado melamina con textura



Guías Hettich  
 Hettich drawer sliding system  
 Guías Hettich  
 Guies Hettich  
 Hettich gidak  
 Guías Hettich

Composición **TAURO 100** (39.4")

- 1 122 24 100 TAURO 100
- 1 517 01 100 SKY
- 1 246 00 100 VERONA LED

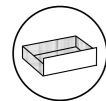

Interior cajones acabado textil  
*Interior of drawer textile finish*  
 Interiores gaveta em acabamento têxtil  
*Interior calaix en acabat tèxtil*  
 Ehun-bukaerazko barnekaldedun kajoia  
*Interior do caixón en acabado têxtil*

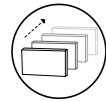

Cajón con cierre amortiguado  
*Drawer fitted with soft closing system*  
 Gaveta com sistema de corredeiras com amortecedor  
*Calaixos amb sistema de tancament suau*  
 Motelgailudun itxierazko kajoia  
*Caixón con peche amortecido*

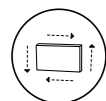

Frente cajón regulable  
*Adjustable front drawer*  
 Fronte da gaveta ajustável  
*Frontal calaix regulable*  
 Neurrirako kajoï aurrekaldea  
*Fronte do caixón axustable*



Puerta con cierre amortiguado  
*Door with soft closing system*  
 Porta com amortecedor  
*Porta amb sistema de tancament suau*  
 Motelgailudun itxierazko atea  
*Porta con peche amortecido*

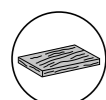

Acabado melamina con textura  
*Textured melamine finish*  
 Cor melamina com textura  
*Acabat melamina amb textura*  
 Testuradun melamina bukatua  
*Acabado melamina con textura*



Guías Hettich  
*Hettich drawer sliding system*  
 Guias Hettich  
*Guias Hettich*  
 Hettich gidak  
*Guias Hettich*

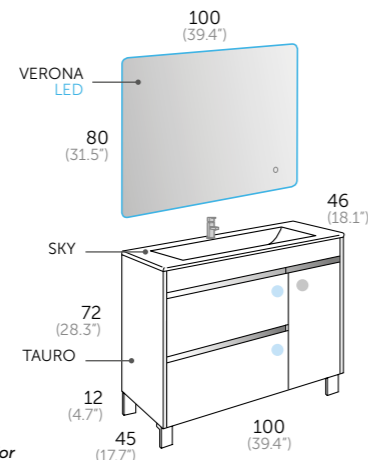

Sistema antivaho  
*Anti fog system*  
 Sistema anti-vapor  
*Sistema antibaf*  
 Lurrunaren kontrako sistema  
*Sistema antivaho*



Sensor de contacto On/ Off  
*Contact sensor On/ Off*  
 Sensor interruptor On/ Off  
*Sensor de contacte On/ Off*  
 On/Off kontaktu sensorea  
*Sensor de contacto On/ Off*



Reversible  
*It is reversible*  
 Reversível  
*Reversible*  
 Itzulgarria  
*Reversible*



Luz ambiental  
*Ambient light*  
 Luz ambiente  
*Llum ambiental*  
 Giro-argia  
*Luz ambiental*

- |  |                           |  |                          |  |  |  |   |  |                           |
|--|---------------------------|--|--------------------------|--|--|--|---|--|---------------------------|
|  | Blanco<br>White<br>Branco |  | Gris<br>Grey<br>Cinzento |  | Roble natural<br>Natural oak<br>Carvalho natural |  | Roble medio<br>Medium oak<br>Carvalho médio |  | Wengué<br>Wenge<br>Wengué |
|  | Zuria<br>Branco           |  | Grisa<br>Gris            |  | Haritz naturala<br>Carballo natural              |  | Haritz ertainekoa<br>Carballo medio         |  | Wenge<br>Wengué           |



## TAURO\_70 (27.5")

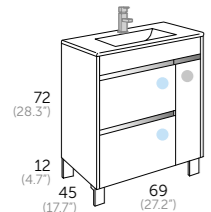

- Acabado Referencia
- Blanco 122 01 070
  - Gris 122 03 070
  - Roble natural 122 24 070
  - Roble medio 122 21 070
  - Wengué 122 20 070

### ENCIMERAS / countertops / lavatorios / lavabos / gainekoak / encimeras



- | Modelo  | Material                 | Referencia                        |
|---------|--------------------------|-----------------------------------|
| ONIX    | cerámica                 | 500 01 070                        |
| TOPACIO |                          | 505 01 070                        |
| JADE    | masa blanca              | 504 01 070                        |
| AMBAR   | mate                     | 506 01 070                        |
| MASAI   |                          | 518 02 070                        |
| CRISTAL | Acabado Metalizado Negro | Referencia 502 11 070, 502 02 070 |
- Más colores en pág. 308-311

### ESPEJOS / mirrors / espelhos / miralls / ispiluak / espellos

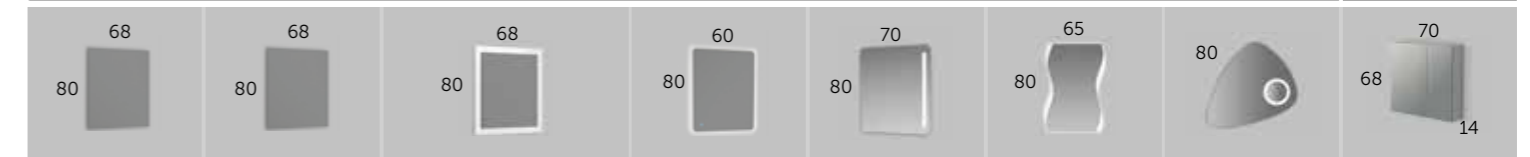

- | Modelo     | Referencia  |
|------------|---|
| MOON       | 200 00 080  |
| CLOUD      | 205 00 080  |
| TOOL       | Referencia 207 01 080, 207 03 080, 207 24 080, 207 21 080 |
| VERONA LED | 246 00 060  |
| MILAN LED  | 268 00 080  |
| MÓDENA LED | 264 00 080  |
| STONE LED  | 261 00 080  |
| FLASH      | 340 11 070  |

## TAURO\_80 (31.5")

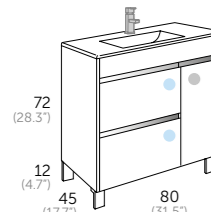

- Acabado Referencia
- Blanco 122 01 080
  - Gris 122 03 080
  - Roble natural 122 24 080
  - Roble medio 122 21 080
  - Wengué 122 20 080

### ENCIMERAS / countertops / lavatorios / lavabos / gainekoak / encimeras



- | Modelo  | Material                 | Referencia                        |
|---------|--------------------------|-----------------------------------|
| ONIX    | cerámica                 | 500 01 080                        |
| TOPACIO | resina                   | 505 01 080                        |
| JADE    | masa blanca              | 504 01 080                        |
| AMBAR   | mate                     | 506 01 080                        |
| MASAI   |                          | 518 02 080                        |
| CRISTAL | Acabado Metalizado Negro | Referencia 502 11 080, 502 02 080 |
- Más colores en pág. 308-311

### ESPEJOS / mirrors / espelhos / miralls / ispiluak / espellos



- | Modelo     | Referencia  |
|------------|---|
| MOON       | 200 00 080  |
| CLOUD      | 205 00 080  |
| SIGMA      | 290 00 080  |
| TOOL       | Referencia 207 01 080, 207 03 080, 207 24 080, 207 21 080 |
| RAIN LED   | 269 00 080  |
| VERONA LED | 246 00 100  |
| HOLMES LED | 263 00 080  |
| SPOTY LED  | 267 00 080  |
| FLASH      | 340 11 080  |

## TAURO\_100 (39.4")

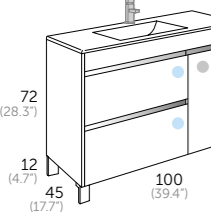

- Acabado Referencia
- Blanco 122 01 100
  - Gris 122 03 100
  - Roble natural 122 24 100
  - Roble medio 122 21 100
  - Wengué 122 20 100

### ENCIMERAS / countertops / lavatorios / lavabos / gainekoak / encimeras



- | Modelo  | Material    | Referencia |
|---------|-------------|------------|
| ONIX    | cerámica    | 500 01 100 |
| SKY     |             | 517 01 100 |
| TOPACIO | resina      | 505 01 100 |
| JADE    | masa blanca | 504 01 100 |
| AMBAR   | mate        | 506 01 100 |
| MASAI   |             | 518 02 100 |
- Más colores en pág. 308-311

### ESPEJOS / mirrors / espelhos / miralls / ispiluak / espellos

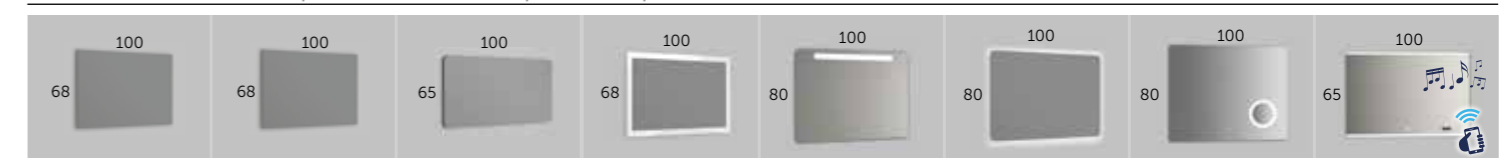

- | Modelo     | Referencia  |
|------------|---|
| MOON       | 200 00 100  |
| CLOUD      | 205 00 100  |
| SIGMA      | 290 00 100  |
| TOOL       | Referencia 207 01 100, 207 03 100, 207 24 100, 207 21 100 |
| RAIN LED   | 269 00 100  |
| VERONA LED | 246 00 100  |
| HOLMES LED | 263 00 100  |
| SPOTY LED  | 267 00 100  |

## AUXILIARES / auxiliary units / auxiliares / auxiliars / osagarriak / auxiliares

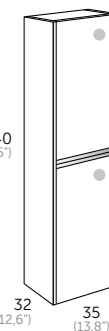

- JOKER columna**
- Acabado Referencia
- Blanco 137 01 335
  - Gris 137 03 335
  - Roble natural 137 24 335
  - Roble medio 137 21 335
  - Wengué 137 20 335

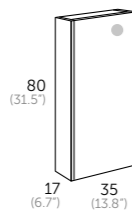

- JOKER colgar**
- Acabado Referencia
- Blanco 137 01 435
  - Gris 137 03 435
  - Roble natural 137 24 435
  - Roble medio 137 21 435
  - Wengué 137 20 435

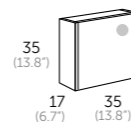

- JOKER auxiliar**
- Acabado Referencia
- Blanco 137 01 445
  - Gris 137 03 445
  - Roble natural 137 24 445
  - Roble medio 137 21 445
  - Wengué 137 20 445



Válvula universal CLIC CLAC  
Referencia 51601

## APLIQUES / spotlights / apliques / aplics / ezarkinak / apliques

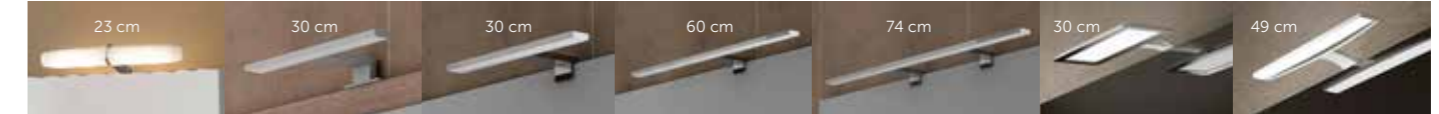

- | Modelo         | Referencia                                     |
|----------------|--|
| EVA LED        | 400 00 011                                     |
| NEREA mate LED | 400 14 161 (luz fría)                          |
| ESTHER LED     | 400 00 121 (luz fría), 400 00 221 (luz cálida) |
| SOFIA LED      | 400 00 141 (luz fría), 400 00 241 (luz cálida) |
| AINHOA LED     | 400 00 151 (luz fría)                          |
| NIKITA LED     | 400 01 171 (luz fría)                          |
| NAYRA LED      | 400 00 181 (luz fría)                          |