

# Mar<sup>\_90</sup>

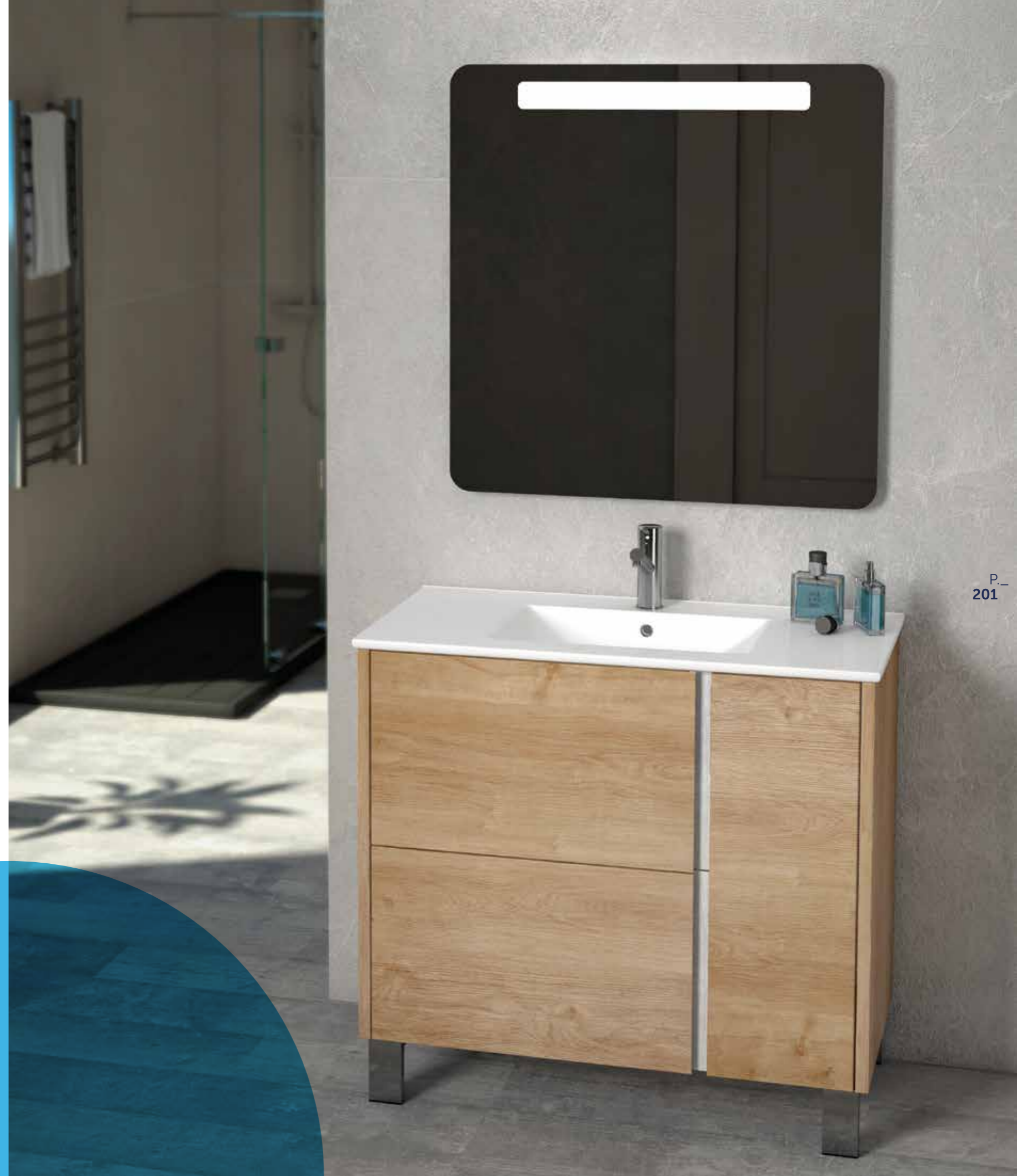

Sigma  
Omega  
Landes  
Landes modular  
Strip  
Cairo  
Dúo  
Ikaro  
Denim  
Lip  
Wave  
Sky  
Trent  
Escorpio  
Tauro  
Wood  
**Mar\_**  
Hole  
Aries  
Galsaky  
Small  
Homy  
Comet  
Tívoli  
Moon  
Dominó

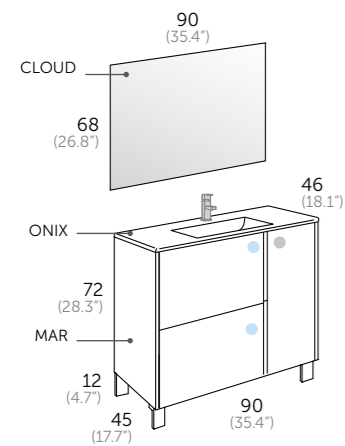



Composición **MAR 90 (35.4")**

- 1 133 01 090 MAR 90
- 1 500 01 090 ONIX
- 1 205 00 090 CLOUD

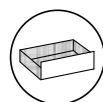

Interior cajones acabado textil  
*Interior of drawer textile finish*  
 Interiores gaveta em acabamento t xtil  
*Interior calaix en acabat t xtil*  
 Ehun-bukaerazko barnekaldeedun kajoia  
*Interior do caix n en acabado t xtil*

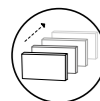

Caj n con cierre amortiguado  
*Drawer fitted with soft closing system*  
 Gaveta com sistema de corredi as com amortecedor  
*Calaixos amb sistema de tancament suau*  
 Motelgailudun itxierazko kajoia  
*Caix n con peche amortecido*

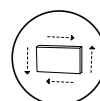

Frente caj n regulable  
*Adjustable front drawer*  
 Frente da gaveta ajust vel  
*Frontal calaix regul ble*  
 Neurrirako kajoj aurrekaldea  
*Fronte do caix n axust ble*



Gu as Hettich  
*Hettich drawer sliding system*  
 Guias Hettich  
*Guias Hettich*  
 Hettich gidak  
*Guias Hettich*

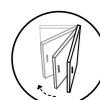

Puerta con cierre amortiguado  
*Door with soft closing system*  
 Porta com amortecedor  
*Porta amb sistema de tancament suau*  
 Motelgailudun itxierazko atea  
*Porta con peche amortecido*

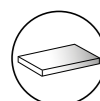

Acabado lacado brillo  
*High gloss lacquered finish*  
 Cor lacado brilho  
*Acabat lacat brillant*  
 Distiradun lakatuzko bukatua  
*Acabado lacado brillo*



Blanco  
 White  
 Branco  
 Blanc  
 Zuria  
 Branco



Roble natural  
 Natural oak  
 Carvalho natural  
 Roure natural  
 Hantz naturala  
 Carballo natural



Nogal oscuro  
 Dark walnut  
 Nogueira escuro  
 Nogueira fosc  
 Inbaurondo iluna  
 Nogueira escura





## MAR\_90 (35.4")

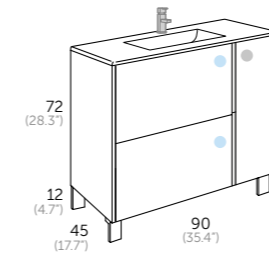

- Acabado Referencia
- Blanco 133 01 090
  - Roble natural 133 24 090
  - Nogal oscuro 133 39 090

### ENCIMERAS

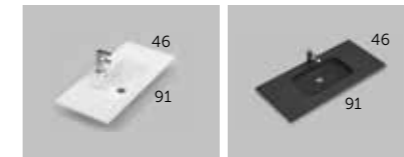

**ONIX** cerámica  
Referencia  
500 01 090

**MASAI**  
Referencia  
518 02 090

Más colores en pág. 308-311



### ESPEJOS / mirrors / espelhos / miralls / ispiluak / espellos

### CAMERINO

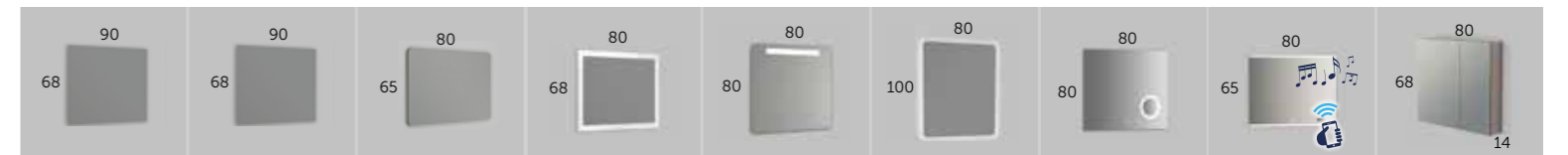

**MOON**  
Referencia  
200 00 090

**CLOUD**  
Referencia  
205 00 090

**SIGMA**  
Referencia  
290 00 080

**TOOL**  
Referencia  
○ 207 01 080  
● 207 24 080

**RAIN LED**  
Referencia  
269 00 080

**VERONA LED**  
Referencia  
246 00 100

**HOLMES LED**  
Referencia  
263 00 080

**SPOTY LED**  
Referencia  
267 00 080

**FLASH**  
Referencia  
340 11 080

### AUXILIARES / auxiliary units / auxiliares / auxiliars / osagarriak / auxiliares

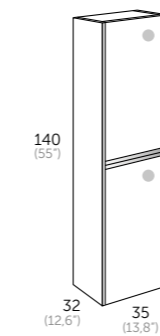

**JOKER** columna  
Acabado Referencia  
○ Blanco 137 01 335  
● Roble natural 137 24 335  
● Nogal oscuro 137 39 335

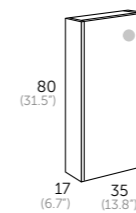

**JOKER** colgar  
Acabado Referencia  
○ Blanco 137 01 435  
● Roble natural 137 24 435  
● Nogal oscuro 137 39 435

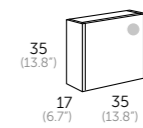

**JOKER** auxiliar  
Acabado Referencia  
○ Blanco 137 01 445  
● Roble natural 137 24 445  
● Nogal oscuro 137 39 445



**Válvula universal CLIC CLAC**  
Referencia  
51601

Interior cajones acabado textil  
*Interior of drawer textile finish*  
Interiores gaveta em acabamento têxtil  
*Interior caixas em acabat têxtil*  
Ehun-bukaerazko barnekaldedun kajoia  
*Interior do caixón en acabado têxtil*

Fronte cajón regulable  
*Adjustable front drawer*  
Fronte da gaveta ajustável  
*Frontal caixas regulabile*  
Neurrirako kajoia aurrekaldea  
*Fronte do caixón axustable*

Cajón con cierre amortiguado  
*Drawer fitted with soft closing system*  
Gaveta com sistema de correções com amortecedor  
*Caixas amb sistema de tancament suau*  
Motelgailudun itxierazko kajoia  
*Caixón con peche amortecido*

Guías Hettich  
*Hettich drawer sliding system*  
Guías Hettich  
*Hettich gidak*  
Guías Hettich

Puerta con cierre amortiguado  
*Door with soft closing system*  
Porta com amortecedor  
*Porta amb sistema de tancament suau*  
Motelgailudun itxierazko atea  
*Porta con peche amortecido*

Acabado melamina con textura  
*Textured melamine finish*  
Cor melamina com textura  
*Acabat melamina amb textura*  
Testuradun melanina bukatua  
*Acabado melamina con textura*

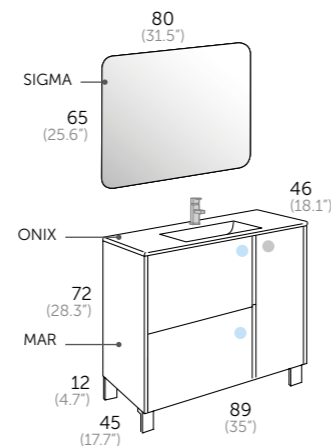

### Composición **MAR 90** (35.4")

- 1 133 39 090 MAR 90
- 1 500 01 090 ONIX
- 1 290 00 080 SIGMA



# MAR



Blanco  
 White  
 Branco  
 Blanc  
 Zuria  
 Branco

Roble natural  
 Natural oak  
 Carvalho natural  
 Roure natural  
 Haritz naturala  
 Carballo natural

Nogal oscuro  
 Dark walnut  
 Nogueira escuro  
 Nogueira fosc  
 Intxaurreondo iluna  
 Nogueira escura

## Descripción:

- Mueble a suelo con patas regulables en altura.
- 2 cajones grandes regulable con cierre amortiguado, interior en acabado textil.
- Puerta en la parte derecha, incluye estante en interior.
- Frontes regulables de 19 mm.
- Tiradores metálicos.
- Acabados en lacado brillo y melamina texturada.



Interior cajones acabado textil  
*Interior of drawer textile finish*  
 Interiores gaveta em acabamento têxtil  
 Interior calaix en acabat tèxtil  
 Ehun-bukaerazko barnekaldedun kajoia  
 Interior do caixón en acabado têxtil



Cajón con cierre amortiguado  
*Drawer fitted with soft closing system*  
 Gaveta com sistema de correiaçoes com amortecedor  
 Calaixos amb sistema de tancament suau  
 Motelgailudun itxierazko kajoia  
 Caixón con peche amortecido



Frente cajón regulable  
*Adjustable front drawer*  
 Fronte da gaveta ajustável  
 Frontal calaix regulable  
 Neurriako kajoj aurrekaldea  
 Fronte do caixón axustable



Guías Hettich  
*Hettich drawer sliding system*  
 Guías Hettich  
 Guies Hettich  
 Hettich gidak  
 Guías Hettich



Puerta con cierre amortiguado  
*Door with soft closing system*  
 Porta com amortecedor  
 Porta amb sistema de tancament suau  
 Motelgailudun itxierazko atea  
 Porta con peche amortecido



Acabado melamina con textura  
*Textured melamine finish*  
 Cor melamina com textura  
 Acabat melamina amb textura  
 Testuradun melanina bukatua  
 Acabado melamina con textura



Acabado lacado brillo  
*High gloss lacquered finish*  
 Cor lacado briho  
 Acabat lacat brillant  
 Distiradun lakatzuko bukatua  
 Acabado lacado brillo

# MAR 90

Acabado	Referencia
Blanco	133 01 090
Roble natural	133 24 090
Nogal oscuro	133 39 090

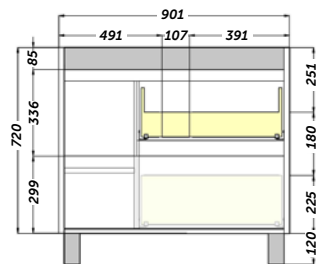
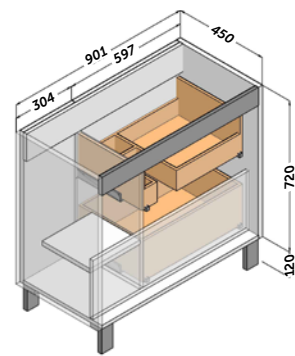

# AUXILIARES / auxiliary units / auxiliares / auxiliars / osagarriak / auxiliares

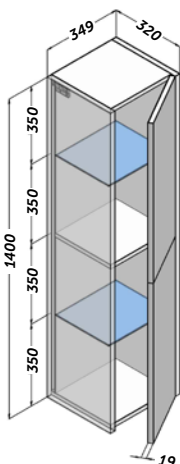

## JOKER columna

Acabado	Referencia
<input type="radio"/> Blanco	137 01 335
<input type="radio"/> Roble natural	137 24 335
<input type="radio"/> Nogal oscuro	137 39 335

El estante de cristal puede cambiar de posición +/- 64 mm



Puerta con cierre amortiguado  
*Door with soft closing system*  
 Porta com amortecedor  
 Porta amb sistema de tancament suau  
 Motelgailudun itxierazko atea  
 Porta con peche amortecido

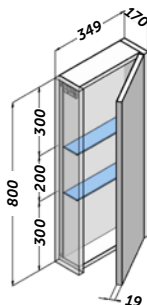

## JOKER colgar

Acabado	Referencia
<input type="radio"/> Blanco	137 01 435
<input type="radio"/> Roble natural	137 24 435
<input type="radio"/> Nogal oscuro	137 39 435



Puerta con cierre amortiguado  
*Door with soft closing system*  
 Porta com amortecedor  
 Porta amb sistema de tancament suau  
 Motelgailudun itxierazko atea  
 Porta con peche amortecido

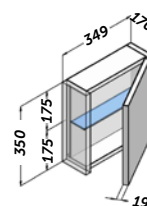

## JOKER auxiliar

Acabado	Referencia
<input type="radio"/> Blanco	137 01 445
<input type="radio"/> Roble natural	137 24 445
<input type="radio"/> Nogal oscuro	137 39 445



El estante de cristal puede cambiar de posición +/- 32 mm

Puerta con cierre amortiguado  
*Door with soft closing system*  
 Porta com amortecedor  
 Porta amb sistema de tancament suau  
 Motelgailudun itxierazko atea  
 Porta con peche amortecido