

# Landes modular

Sigma  
Omega  
Landes  
**Landes modular**  
Strip  
Cairo  
Dúo  
Ikaro  
Denim  
Lip  
Wave  
Sky  
Trent  
Escorpio  
Tauro  
Wood  
Mar  
Hole  
Aries  
Galsaky  
Small  
Homy  
Comet  
Tívoli  
Moon  
Dominó

80/90/100/110/120/140/  
150/160/180/200



# encimera\_Ambar 80/90/100/110/120

Blanco mate  
Matte white  
Branco mate  
Blanc mat  
Zuri matea  
Branco mate

Roble natural  
Natural oak  
Carvalho natural  
Roure natural  
Haritz naturala  
Carballo natural

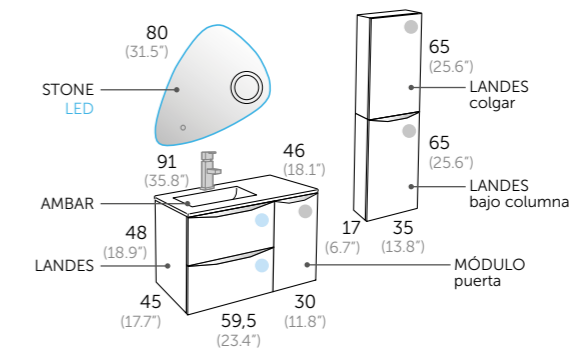

## Composición LANDES Ambar 90 (35.4')

- 1 112 35 060 LANDES 60
- 1 112 35 030 MÓDULO puerta dcha.
- 1 506 01 091 AMBAR
- 1 261 00 080 STONE LED

## Auxiliares

- 1 112 35 435 LANDES colgar
- 1 112 35 035 LANDES bajo columna dcha.

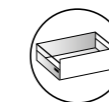

Interior cajones costilla metálicas  
*Metal interior drawers*  
Interior gaveta com guia metálica  
*Interior calaix costella metálica*  
Kaxoi barnekaldea saihets metalikoekin  
*Interior caixóns costela metálica*



Cajón con cierre amortiguado  
*Drawer fitted with soft closing system*  
Gaveta com sistema de corredeiras com amortecedor  
*Calaixos amb sistema de tancament suau*  
Motelgailudun itxierazko kajoia  
*Caixón con peche amortecido*



Guías Hettich  
*Hettich drawer sliding system*  
Guías Hettich  
*Guies Hettich*  
Hettich gidak  
*Guías Hettich*



Organizador en cajón superior  
*Organizer unit on top drawer*  
Organizador de gaveta  
*Organizador en calaixos superiors*  
Antolatzailea goikaldeko kajoian  
*Organizador en caixón superior*



Puerta con apertura push  
*Door with push to open*  
Porta abertura com push  
*Porta amb obertura push*  
Push irekieradun atea  
*Porta con apertura push*



Puerta con cierre amortiguado  
*Door with soft closing system*  
Porta com amortecedor  
*Porta amb sistema de tancament suau*  
Motelgailudun itxierazko atea  
*Porta con peche amortecido*



Hidrófugo  
*More resistant to water*  
À prova d'água  
*Hidrofulg*  
Hidrofulgoa  
*Hidrofulgo*



Sistema antivaho  
*Anti fog system*  
Sistema anti-vapor  
*Sistema antibaf*  
Lurrunaren kontrako sistema  
*Sistema antivaho*



Sensor de contacto On/ Off  
*Contact sensor On/ Off*  
Sensor interruptor On/ Off  
*Sensor de contacte On/ Off*  
On/Off kontaktu sentsorea  
*Sensor de contacto On/ Off*



Lupa aumento x3  
*Magnifying zoom in Mirror*  
Lupa aumento 3x  
*Lupa augment 3x*  
3x-eko haundiagotze lupa  
*Lupa aumento 3x*

# encimera Ambar



- Blanco mate  
Matte white  
Branco mate
- Roble natural  
Natural oak  
Carvalho natural
- Blanc mat  
Haritz naturala  
Carballo natural
- Zuri matea  
Branco mate

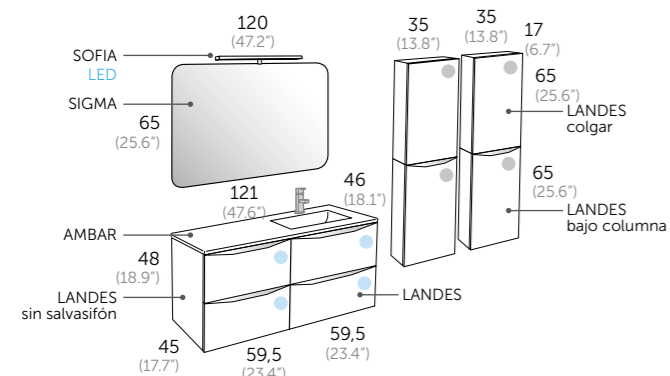

## Composición LANDES Ambar 120 (47.2")

- 1 112 35 060 LANDES 60
- 1 112 35 061 LANDES 60 (sin salvasifón)
- 1 506 01 123 AMBAR
- 1 290 00 120 SIGMA
- 1 400 00 141 SOFIA LED

## Auxiliares

- 2 112 35 435 LANDES colgar
- 2 112 35 035 LANDES bajo columna dcha.

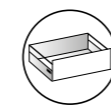
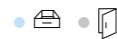

Interior cajones costilla metálicas  
*Metal interior drawers*  
Interior gaveta com guía metálica  
*Interior calaix costella metàl·lica*  
Kaxoi barnekaldea saihets metalikoekin  
*Interior caixóns costela metálica*

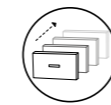

Cajón con cierre amortiguado  
*Drawer fitted with soft closing system*  
Gaveta com sistema de corredeiras com amortecedor  
*Calaixos amb sistema de tancament suau*  
Motelgailudun itxierazko kajoia  
*Caixón con peche amortecido*



Guías Hettich  
*Hettich drawer sliding system*  
Guias Hettich  
*Hettich gidak*  
Guías Hettich

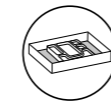

Organizador en cajón superior  
*Organizer unit on top drawer*  
Organizador de gaveta  
*Organizador en calaixos superiors*  
Antolatzailea goikaldeko kajoian  
*Organizador en caixón superior*



Puerta con apertura push  
*Door with push to open*  
Porta abertura com push  
*Porta amb obertura push*  
Push irekieradun atea  
*Porta con apertura push*



Puerta con cierre amortiguado  
*Door with soft closing system*  
Porta com amortecedor  
*Porta amb sistema de tancament suau*  
Motelgailudun itxierazko atea  
*Porta con peche amortecido*

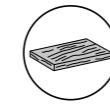

Acabado melamina con textura  
*Textured melamine finish*  
Cor melamina com textura  
*Acabat melamina amb textura*  
Testuradun melamina bukatua  
*Acabado melamina con textura*



Hidrófugo  
*More resistant to water*  
À prova d'aigua  
*Hidrófug*  
Hidrófugo

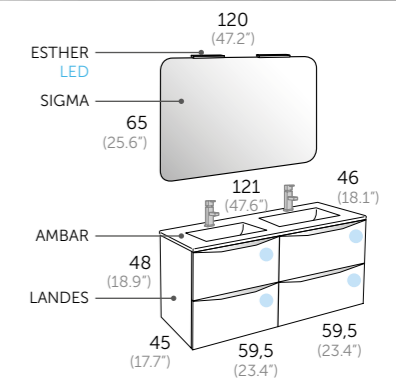

## Composición LANDES Ambar 120 (47.2")

- 2 112 24 060 LANDES 60
- 1 506 01 122 AMBAR
- 1 290 00 120 SIGMA
- 2 400 00 121 ESTHER LED



# 100/110/120/140/150/160/180/200 **Sobreponer**

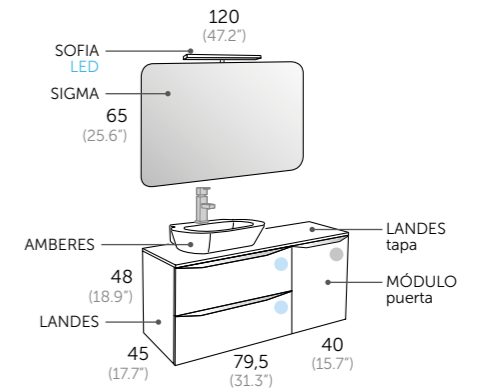

## Composición **LANDES** sobreponer **120** (47.2")

- 1 112 24 080 LANDES 80
- 1 112 24 040 MÓDULO puerta dcha.
- 1 112 24 212 LANDES tapa
- 1 507 01 003 AMBERES
- 1 290 00 120 SIGMA
- 1 400 00 141 SOFIA LED

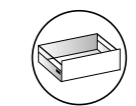

Interior cajones costilla metálicas  
*Metal interior drawers*  
 Interior gaveta com guia metálica  
 Interior calaix costella metálica  
 Kaxoi barnekaldea saihets metalikoekin  
 Interior caixóns costela metálica

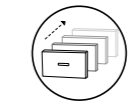

Cajón con cierre amortiguado  
*Drawer fitted with soft closing system*  
 Gaveta com sistema de corredeças com amortecedor  
 Calaixos amb sistema de tancament suau  
 Motelgailudun itxierazko kajoia  
 Caixón con peche amortecido



Guías Hettich  
*Hettich drawer sliding system*  
 Guias Hettich  
 Guias Hettich  
 Hettich gidak  
 Guias Hettich

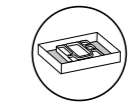

Organizador en cajón superior  
*Organizer unit on top drawer*  
 Organizador de gaveta  
 Organizador en calaixos superiors  
 Antolatzailea goikaldeko kajoian  
 Organizador en caixón superior



Puerta con cierre amortiguado  
*Door with soft closing system*  
 Porta com amortecedor  
 Porta amb sistema de tancament suau  
 Motelgailudun itxierazko atea  
 Porta con peche amortecido

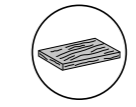

Acabado melamina con textura  
*Textured melamine finish*  
 Cor melamina com textura  
 Acabat melamina amb textura  
 Testuradun melanina bukatua  
 Acabado melanina con textura



Hidrófugo  
*More resistant to water*  
 À prova d'água  
 Hidrófuga  
 Hidrofugoa  
 Hidrófugo

# Sobreponer





- Blanco mate  
Matte white  
Branco mate  
Blanc mat  
Zuri matea  
Branco mate
- Roble natural  
Natural oak  
Carvalho natural  
Roire natural  
Haritz naturala  
Carballo natural

-  Organizador en cajón superior  
*Organizer unit on top drawer*  
Organizador de gaveta  
*Organizador en caixas superiores*  
Antolatzailea goikaldeko kajoian  
*Organizador en caixón superior*
-  Interior cajones costilla metálica  
*Metal interior drawers*  
Interior gaveta con guía metálica  
*Interior calaix costella metálica*  
Kaxoi barnekaldea sailhets metalikoekin  
*Interior caixóns costela metálica*
-  Cajón con cierre amortiguado  
*Drawer fitted with soft closing system*  
Gaveta com sistema de correções com amortecedor  
*Motelgailudun itxierazko atea*  
Caixón con peche amortecido
-  Guías Hettich  
*Hettich drawer sliding system*  
Guías Hettich  
*Hettich gidak*  
Guías Hettich

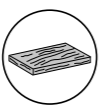
-  Puerta con cierre amortiguado  
*Door with soft closing system*  
Porta com amortecedor  
*Porta amb sistema de tancament suau*  
Motelgailudun itxierazko atea  
*Porta con peche amortecido*

-  Acabado melamina con textura  
*Textured melamine finish*  
Cor melamina com textura  
*Acabat melamina amb textura*  
Testuradun melanina bukatua  
*Acabado melanina con textura*

-  Hidrófugo  
*More resistant to water*  
À prova d'água  
*Hidrófug*  
Hidrofugoa  
*Hidrófugo*

-  Sistema antivaho  
*Anti fog system*  
Sistema anti-vapor  
*Sistema antibaf*  
Lurrunaren kontrako sistema  
*Sistema antivaho*

-  Sensor de contacto On/ Off  
*Contact sensor On/ Off*  
Sensor interruptor On/ Off  
*Sensor de contacte On/ Off*  
On/Off kontaktu sentorea  
*Sensor de contacto On/ Off*

-  Reversible  
*It is reversible*  
Reversível  
*Reversible*  
Itzulgarria  
*Reversible*

-  Luz ambiental  
*Ambient light*  
Luz ambiente  
*Luz ambiental*  
Luz ambiental  
*Luz ambiental*

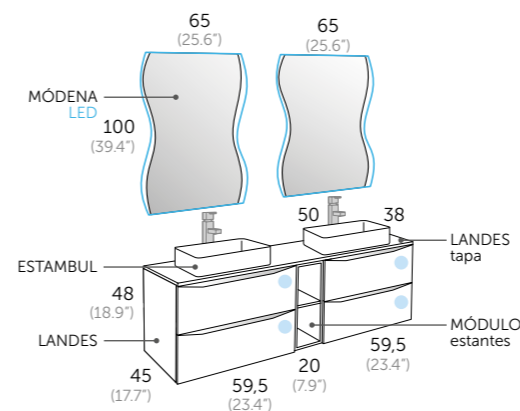

Composición **LANDES** sobreponer **140 (55")**

- 2 112 35 060 LANDES 60
- 1 112 35 022 MÓDULO estantes
- 1 112 35 214 LANDES tapa
- 2 507 01 005 ESTAMBUL
- 2 264 00 100 MÓDENA LED

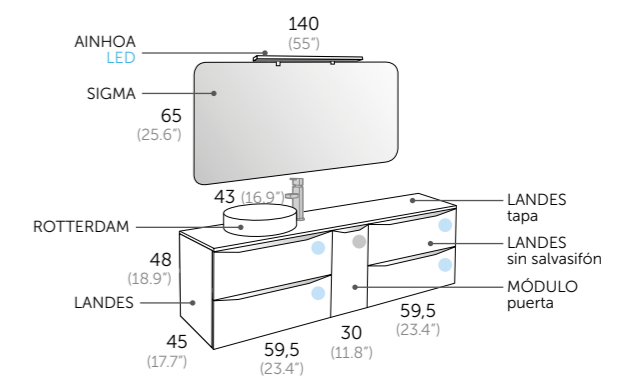

Composición **LANDES** sobreponer **150 (59")**

- 1 112 24 060 LANDES 60
- 1 112 24 061 LANDES 60 sin salvafisión
- 1 112 24 030 MÓDULO puerta dcha.
- 1 112 24 215 LANDES tapa
- 1 507 01 004 ROTTERDAM
- 1 290 00 140 SIGMA
- 1 400 00 151 AINHOA LED



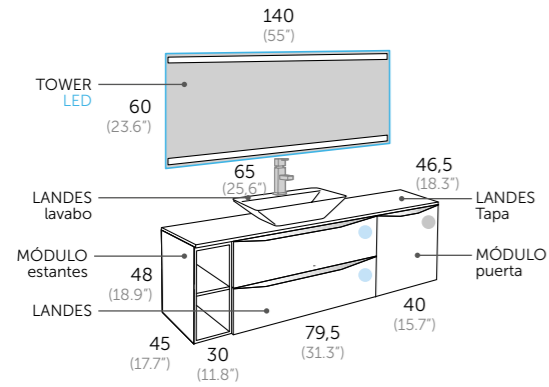

Composición **LANDES sobreponer 150 (59")**

- 1 112 35 080 LANDES 80
- 1 112 35 000 MÓDULO estantes
- 1 112 24 040 MÓDULO puerta dcha.
- 1 112 35 215 LANDES tapa
- 1 507 01 002 LANDES lavabo
- 1 262 00 140 TOWER LED

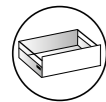

Interior cajones costilla metálicas  
*Metal interior drawers*  
 Interior gaveta com guia metálica  
*Interior calaix costella metálica*  
 Kaxoi barnekaldea saihets metalikoekin  
*Interior caixons costela metálica*

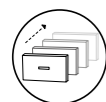

Cajón con cierre amortiguado  
*Drawer fitted with soft closing system*  
 Gaveta com sistema de correções com amortecedor  
*Caixaos amb sistema de tancament suau*  
 Motelgailudun itxierazko kajoia  
*Caixón con peche amortecido*



Guías Hettich  
*Hettich drawer sliding system*  
 Guias Hettich  
*Guias Hettich*  
 Hettich gidak  
*Guias Hettich*

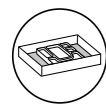

Organizador en cajón superior  
*Organizer unit on top drawer*  
 Organizador de gaveta  
*Organizador en calaixos superiors*  
 Antolatzailea goikaldeko kajoian  
*Organizador en caixón superior*



Puerta con cierre amortiguado  
*Door with soft closing system*  
 Porta com amortecedor  
*Porta amb sistema de tancament suau*  
 Motelgailudun itxierazko atea  
*Porta con peche amortecido*

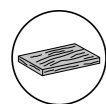

Acabado melamina con textura  
*Textured melamine finish*  
 Cor melamina com textura  
*Acabat melamina amb textura*  
 Testuradun melamina bukatua  
*Acabado melamina con textura*



Hidrófugo  
*More resistant to water*  
 A prova d'água  
*Hidrófug*  
 Hidrofugoa  
*Hidrófugo*



Sistema antivaho  
*Anti fog system*  
 Sistema anti-vapor  
*Sistema antibaf*  
 Lurrunaren kontrako sistema  
*Sistema antivaho*



Sensor infrarrojo On/Off  
*Infrared sensor On/Off*  
 Sensor infravermelho On/ Off  
*Sensor infraroig On/ Off*  
 On/Off sentzore infragorria  
*Sensor infravermello On/Off*



Reversible  
*It is reversible*  
 Reversível  
*Reversible*  
 Itzulgarria  
*Reversible*

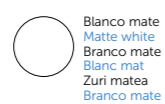

Blanco mate  
*Matte white*  
 Branco mate  
*Blanc mat*  
 Zuri matea  
*Branco mate*

Roble natural  
*Natural oak*  
 Carvalho natural  
*Roure natural*  
 Haritz naturala  
*Carballo natural*



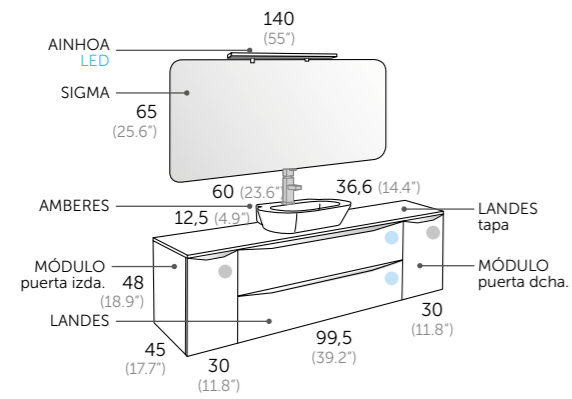

## Composición **LANDES sobreponer 160 (63")**

- 1 112 24 100 LANDES 100
- 1 112 24 030 MÓDULO puerta dcha.
- 1 112 24 031 MÓDULO puerta izda.
- 1 112 24 216 LANDES tapa
- 1 507 01 003 AMBERES
- 1 290 00 140 SIGMA
- 1 400 00 151 AINHOA LED

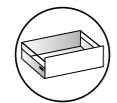

Interior cajones costilla metálicas  
*Metal interior drawers*  
 Interior gaveta com guia metálica  
*Interior calaix costella metàl·lica*  
 Kaxoi barnekaldea saihets metalikoeikin  
*Interior caixóns costela metálica*



Cajón con cierre amortiguado  
*Drawer fitted with soft closing system*  
 Gaveta com sistema de corrediças com amortecedor  
*Calaixos amb sistema de tancament suau*  
 Motelgailudun itxierazko kajoia  
*Caixón con peche amortecido*



Guías Hettich  
*Hettich drawer sliding system*  
 Guías Hettich  
*Guias Hettich*  
 Hettich gidak  
*Guías Hettich*



Organizador en cajón superior  
*Organizer unit on top drawer*  
 Organizador de gaveta  
*Organitzador en calaixos superiors*  
 Antolatzaila goikaldeko kajoian  
*Organizador en caixón superior*



Puerta con cierre amortiguado  
*Door with soft closing system*  
 Porta com amortecedor  
 Porta amb sistema de tancament suau  
 Motelgailudun itxierazko atea  
*Porta con peche amortecido*



Acabado melamina con textura  
*Textured melamine finish*  
 Cor melamina com textura  
*Acabat melamina amb textura*  
 Testuradun melamina bukatua  
*Acabado melamina con textura*



Hidrófugo  
*More resistant to water*  
 À prova d'água  
 Hidrófug  
 Hidrofugoa  
 Hidrófugo

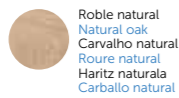

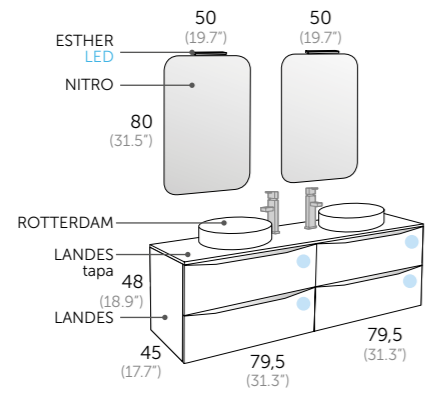

## Composición **LANDES** sobreponer **160** (63")

2	112	24	080	LANDES 80
1	112	24	216	LANDES tapa
2	507	01	004	ROTTERDAM
2	241	00	050	NITRO
2	400	00	121	ESTHER LED

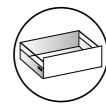

Interior cajones costilla metálicas  
*Metal interior drawers*  
Interior gaveta com guia metálica  
*Interior calaix costella metálica*  
Kaxoi barnekaldea sailhets metalikoekin  
*Interior caixóns costela metálica*

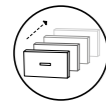

Cajón con cierre amortiguado  
*Drawer fitted with soft closing system*  
Gaveta com sistema de correções com amortecedor  
*Caixaos amb sistema de tancament suau*  
Motelgailudun itxierazko kajoia  
*Caixón con peche amortecido*



Guías Hettich  
*Hettich drawer sliding system*  
Guías Hettich  
*Guias Hettich*  
Hettich gidak  
*Guias Hettich*

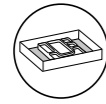

Organizador en cajón superior  
*Organizer unit on top drawer*  
Organizador de gaveta  
*Organizador en calaixos superiors*  
Antolatzailea goikaldeko kajoian  
*Organizador en caixón superior*

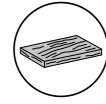

Acabado melamina con textura  
*Textured melamine finish*  
Cor melamina com textura  
*Acabat melamina amb textura*  
Testuradun melamina bukatua  
*Acabado melamina con textura*



Hidrófugo  
*More resistant to water*  
À prova d'água  
*Hidrófug*  
Hidrofugoa  
*Hidrófugo*

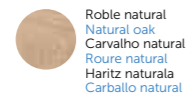
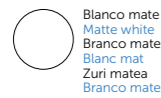



# Landes\_modular

## LANDES\_60 (23.6")

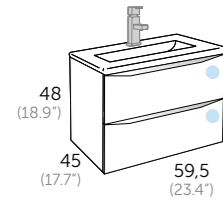

**LANDES 60**  
con salvafón

Acabado Referencia  
 ○ Blanco mate 112 35 060  
 ● Roble natural 112 24 060

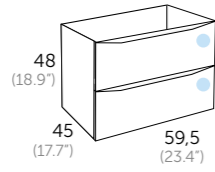

**LANDES 60**  
sin salvafón

Acabado Referencia  
 ○ Blanco mate 112 35 061  
 ● Roble natural 112 24 061

## LANDES\_80 (31.5")

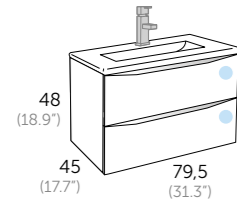

**LANDES 80**  
con salvafón

Acabado Referencia  
 ○ Blanco mate 112 35 080  
 ● Roble natural 112 24 080

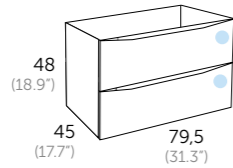

**LANDES 80**  
sin salvafón

Acabado Referencia  
 ○ Blanco mate 112 35 081  
 ● Roble natural 112 24 081

## LANDES\_100 (39.4")

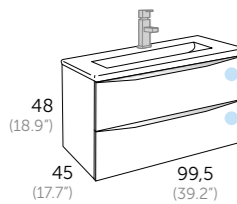

**LANDES 100**  
con salvafón

Acabado Referencia  
 ○ Blanco mate 112 35 100  
 ● Roble natural 112 24 100

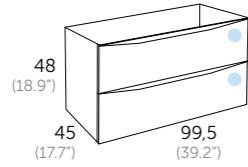

**LANDES 100**  
sin salvafón

Acabado Referencia  
 ○ Blanco mate 112 35 101  
 ● Roble natural 112 24 101

## LANDES\_120 (47.2")

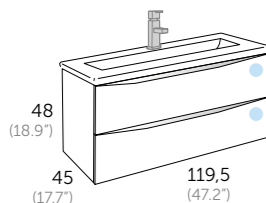

**LANDES 120**  
con salvafón

Acabado Referencia  
 ○ Blanco mate 112 35 120  
 ● Roble natural 112 24 120

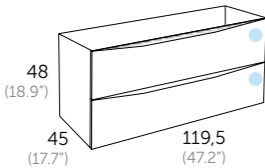

**LANDES 120**  
sin salvafón

Acabado Referencia  
 ○ Blanco mate 112 35 121  
 ● Roble natural 112 24 121

## MÓDULOS / module / modulo / mòduls / modulua / módulo

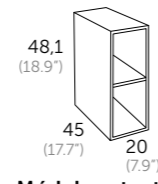

**Módulo estantes 20**

Acabado Referencia  
 ○ Blanco mate 112 35 022  
 ● Roble natural 112 24 022

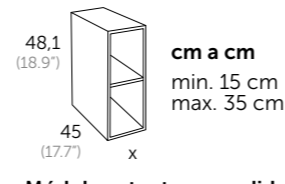

**Módulo estantes a medida**

Acabado Referencia  
 ○ Blanco mate 112 35 000  
 ● Roble natural 112 24 000

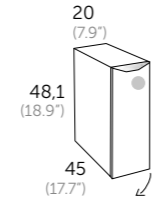

**Módulo izda. 20**

Acabado Referencia  
 ○ Blanco mate 112 35 021  
 ● Roble natural 112 24 021

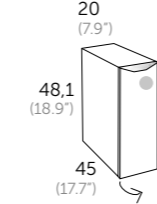

**Módulo dcha. 20**

Acabado Referencia  
 ○ Blanco mate 112 35 020  
 ● Roble natural 112 24 020

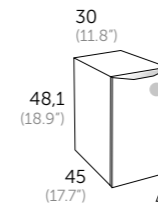

**Módulo izda. 30**

Acabado Referencia  
 ○ Blanco mate 112 35 031  
 ● Roble natural 112 24 031

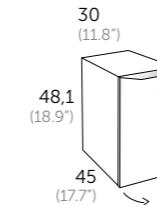

**Módulo dcha. 30**

Acabado Referencia  
 ○ Blanco mate 112 35 030  
 ● Roble natural 112 24 030

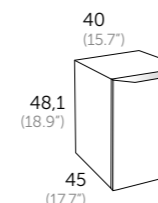

**Módulo izda. 40**

Acabado Referencia  
 ○ Blanco mate 112 35 041  
 ● Roble natural 112 24 041

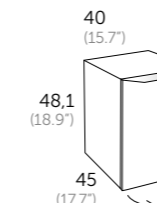

**Módulo dcha. 40**

Acabado Referencia  
 ○ Blanco mate 112 35 040  
 ● Roble natural 112 24 040

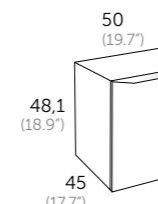

**Módulo izda. 50**

Acabado Referencia  
 ○ Blanco mate 112 35 051  
 ● Roble natural 112 24 051

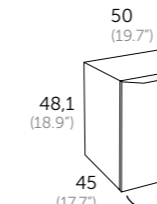

**Módulo dcha. 50**

Acabado Referencia  
 ○ Blanco mate 112 35 050  
 ● Roble natural 112 24 050

## ENCIMERAS\_Ambar / countertops / lavatorios / lavabos / gaineoak / encimeras

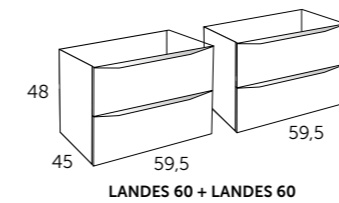

LANDES 60 + LANDES 60



AMBAR 120

Medida	Referencia
120 (2 senos)	506 01 122
120 (1 s.) izda.	506 01 121
120 (1 s.) dcha.	506 01 123

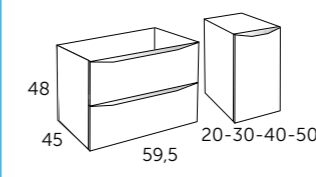

LANDES 60 + MÓDULO



AMBAR DESPLAZADA

IZDA.		DCHA.	
Medida	Referencia	Medida	Referencia
80 (60+20)	506 01 081	80 (60+20)	506 01 083
90 (60+30)	506 01 091	90 (60+30)	506 01 093
100 (60+40)	506 01 101	100 (60+40)	506 01 103
110 (60+50)	506 01 111	110 (60+50)	506 01 113

## LANDES TAPA\_sobreponer

tops / tampos / tapes / eztalkiak / tapas

Fabricadas en MDF hidrófugo y chapadas con laser.  
Las tapas se sirven sin agujero.



Blanco mate		Roble natural	
Medida	Referencia	Medida	Referencia
60 x 45	112 35 206	60 x 45	112 24 206
80 x 45	112 35 208	80 x 45	112 24 208
90 x 45	112 35 209	90 x 45	112 24 209
100 x 45	112 35 210	100 x 45	112 24 210
110 x 45	112 35 211	110 x 45	112 24 211
120 x 45	112 35 212	120 x 45	112 24 212
130 x 45	112 35 213	130 x 45	112 24 213
140 x 45	112 35 214	140 x 45	112 24 214
150 x 45	112 35 215	150 x 45	112 24 215
160 x 45	112 35 216	160 x 45	112 24 216
180 x 45	112 35 218	180 x 45	112 24 218
200 x 45	112 35 220	200 x 45	112 24 220
x cm lineal	112 35 999	x cm lineal	112 24 999

## MASAI TAPA\_sobreponer

tops / tampos / tapes / eztalkiak / tapas

Hecho de carga mineral recubierto de poliuretano acrílico.  
Las tapas se sirven sin agujero.



Negro	
Medida	Referencia
Masai 60	519 02 060
Masai 80	519 02 080
Masai 90	519 02 090
Masai 100	519 02 100
Masai 105	519 02 105
Masai 120	519 02 120
Masai 140	519 02 140
Masai 150	519 02 150
Masai 160	519 02 160
Masai 180	519 02 180
Masai 200	519 02 200

Más colores en pág. 313

## LAVABOS\_sobreponer

washbasins / lavatorio posuar / lavabo sobreposar / gainjarritako konketa / lavabo sobrepoñer



**ROTTERDAM**  
cerámica

Referencia 507 01 004  
Altura: 10,5 cm



**ESTAMBUL**  
cerámica

Referencia 507 01 005  
Altura: 10,5 cm



**AMBERES**  
cerámica

Referencia 507 01 003  
Altura: 12,5 cm



**LANDES**  
cerámica

Referencia 507 01 002  
Altura: 13 cm

## APLIQUES / más opciones página 326



**ESTHER LED**

Referencia 400 00 121  
luz fría  
400 00 221  
luz cálida



**SOFIA LED**

Referencia 400 00 141  
luz fría  
400 00 241  
luz cálida

## ESPEJOS / mirrors / espelhos / miralls / ispiluak / espellos

en páginas 316 - 325

## AUXILIARES / auxiliary units / auxiliares / auxiliars / osagarriak / auxiliares

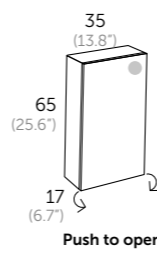

**LANDES**  
colgar izda./dcha.

Acabado Referencia  
 ○ Blanco mate 112 35 435  
 ● Roble natural 112 24 435

Push to open

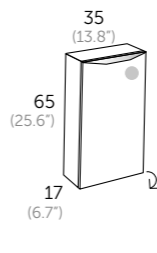

**LANDES**  
bajo columna izda.

Acabado Referencia  
 ○ Blanco mate 112 35 036  
 ● Roble natural 112 24 036

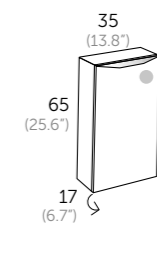

**LANDES**  
bajo columna dcha.

Acabado Referencia  
 ○ Blanco mate 112 35 035  
 ● Roble natural 112 24 035



# LANDES modular



MADE IN SPAIN

Blanco mate  
Matte white  
Branco mate  
Blanc mat  
Zuri matea  
Branco mate

Roble natural  
Natural oak  
Carvalho natural  
Roire natural  
Haritz naturala  
Carballo natural

## Descripción:

- Mueble suspendido en estructura 19 mm de grueso.
- Sujeción ajustable en altura y profundidad con sistema antivuelco.
- 2 cajones de costillas metálicas ajustables con extracción total y cierre amortiguado.
- Frontes de 19 mm.
- Tiradores de aluminio.
- Costados chapados en laser.
- Fabricado en material hidrófugo.



Interior cajones costilla metálicas  
*Metal interior drawers*  
Interior gaveta con guía metálica  
*Interior calaix costella metàlica*  
Kaxoi barnekaldea saihets metalikoekin  
*Interior caixons costela metálica*



Puerta con cierre amortiguado  
*Door with soft closing system*  
Porta com amortecedor  
*Porta amb sistema de tancament suau*  
Motelgailudun itxierazko atea  
*Porta con peche amortecido*



Cajón con cierre amortiguado  
*Drawer fitted with soft closing system*  
Gaveta com sistema de corriçes com amortecedor  
*Calaixos amb sistema de tancament suau*  
Motelgailudun itxierazko kajoia  
*Caixon con peche amortecido*



Acabado melamina con textura  
*Textured melamine finish*  
Cor melamina com textura  
*Acabat melamina amb textura*  
Testuradun melamina bukatua  
*Acabado melamina con textura*



Guías Hettich  
*Hettich drawer sliding system*  
Guías Hettich  
*Hettich gidak*  
Guías Hettich  
*Hettich gidak*  
Guías Hettich



Hidrófugo  
*More resistant to water*  
À prova d'água  
*Hidrofüg*  
Hidrofügoa  
*Hidrofügo*



Organizador en cajón superior  
*Organizer unit on top drawer*  
Organizador de gaveta  
*Organizador en calaixos superiors*  
Antolatzailea goikaldeko kajoian  
*Organizador en caixon superior*

## LANDES 60

sin salvasifón

Acabado	Referencia
Blanco mate	112 35 061
Roble natural	112 24 061

## LANDES 80

sin salvasifón

Acabado	Referencia
Blanco mate	112 35 081
Roble natural	112 24 081

## LANDES 100

sin salvasifón

Acabado	Referencia
Blanco mate	112 35 101
Roble natural	112 24 101

## LANDES 120

sin salvasifón

Acabado	Referencia
Blanco mate	112 35 121
Roble natural	112 24 121

## MÓDULOS

### Módulo estante 20

Acabado	Referencia
Blanco mate	112 35 022
Roble natural	112 24 022

### Módulo 20 izda.

Acabado	Referencia
Blanco mate	112 35 021
Roble natural	112 24 021

### Módulo 30 izda.

Acabado	Referencia
Blanco mate	112 35 031
Roble natural	112 24 031

### Módulo 40 izda.

Acabado	Referencia
Blanco mate	112 35 041
Roble natural	112 24 041

### Módulo 50 izda.

Acabado	Referencia
Blanco mate	112 35 051
Roble natural	112 24 051

### Módulo estante a medida

cm a cm min. 15 cm / max. 35 cm

Acabado	Referencia
Blanco mate	112 35 000
Roble natural	112 24 000

### Módulo 20 dcha.

Acabado	Referencia
Blanco mate	112 35 020
Roble natural	112 24 020

### Módulo 30 dcha.

Acabado	Referencia
Blanco mate	112 35 030
Roble natural	112 24 030

### Módulo 40 dcha.

Acabado	Referencia
Blanco mate	112 35 040
Roble natural	112 24 040

### Módulo 50 dcha.

Acabado	Referencia
Blanco mate	112 35 050
Roble natural	112 24 050

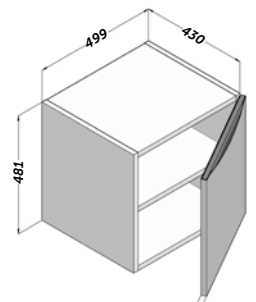
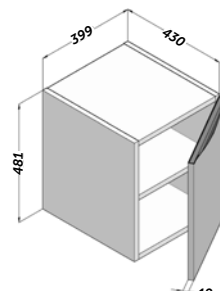
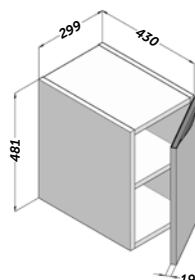
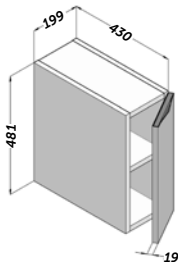
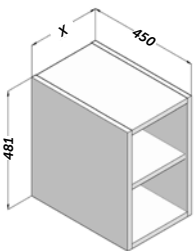

## TAPA LANDES



Fabricadas en MDF hidrófugo y chapadas con laser.

Las tapas se sirven sin agujero.

Blanco mate		Roble natural	
Medida	Referencia	Medida	Referencia
60 x 45	112 35 206	60 x 45	112 24 206
80 x 45	112 35 208	80 x 45	112 24 208
90 x 45	112 35 209	90 x 45	112 24 209
100 x 45	112 35 210	100 x 45	112 24 210
110 x 45	112 35 211	110 x 45	112 24 211
120 x 45	112 35 212	120 x 45	112 24 212
130 x 45	112 35 213	130 x 45	112 24 213
140 x 45	112 35 214	140 x 45	112 24 214
150 x 45	112 35 215	150 x 45	112 24 215
160 x 45	112 35 216	160 x 45	112 24 216
180 x 45	112 35 218	180 x 45	112 24 218
200 x 45	112 35 220	200 x 45	112 24 220
x cm lineal	112 35 999	x cm lineal	112 24 999